

# The record of Deinotheriidae from the Miocene of the Swiss Jura Mountains (Jura Canton, Switzerland)

<sup>1</sup> Gagliardi Fanny, <sup>2,3</sup> Maridet Olivier & <sup>2,3</sup> Becker Damien

<sup>1</sup> Biology, University of Neuchâtel, CH-2000 Neuchâtel, Switzerland; fanny.gagliardi@unine.ch

<sup>2</sup> Jurassica Museum, Route de Fontenais 21, CH-2900 Porrentruy, Switzerland; damien.becker@jurassica.ch, olivier.maridet@jurassica.ch [corresponding authors]

<sup>3</sup> Earth Sciences, University of Fribourg, Chemin du Musée 6, CH-1900 Fribourg, Switzerland

## Abstract:

The Miocene sands of the Swiss Jura Mountains, long exploited in quarries for the construction industry, have yielded abundant fossil remains of large mammals. Among Deinotheriidae (Proboscidea), two species, *Prodeinotherium bavaricum* and *Deinotherium giganteum*, had previously been identified in the Delémont valley, but never described. A third species, *Deinotherium levius*, from the locality of Charmoille in Ajoie, is reported herein for the first time in Switzerland. These occurrences are dated from the late early to the early late Miocene, correlating to the European Mammal biozones MN4 to MN9. The study is completed by a discussion on the palaeobiogeography of proboscidea at European scale.

**Key words:** *Prodeinotherium*, *Deinotherium*, Bois de Raubers, Ajoie, Miocene, Jura, Switzerland.

## Introduction

The order Proboscidea currently regroups large mammals whose common characteristic is the possession of a trunk and tusks. Within the Afrotheria superorder, it has for sister group the Sirenia or dugongs and manatees). Its extant representatives belong to the Elephantidae family with only three species of elephants living in Africa or Asia (*Loxodonta africana*, *Loxodonta cyclotis* and *Elephas maximus*). However, this order is much more diversified in the fossil record.

The Proboscideans have an African origin with the basal genus *Erytherium*, found in the early late Paleocene of Morocco (Gheerbrant 2009), as well as other primitive forms with small sizes belonging to the genera *Numidotherium* and *Barytherium*. These primitive forms were only found in the late

early Eocene and the late Eocene and early Oligocene, respectively, of Africa (Tassy 1990). The gomphotheres (Gomphotheriidae) and the **deinotheres** (Deinotheriidae) are the **deinotheres** proboscideans found outside of Africa in the fossil record. Their occurrence in Europe is linked to the Proboscidean Datum Event (*sensu* Tassy 1990) of the late early Miocene (ca. 19.5-17.5 Ma; Göhlich 1999). This biogeographic event resulted from the counter clockwise rotation of Africa and Arabia plates leading to a collision with the Anatolian plate and the formation of a landbridge connecting Africa and Eurasia at the end of the early Miocene (Röhlf 1999a, b). This geographic change allowed remarkable terrestrial mammal exchanges including the gomphotheres and the **deinotheres** (e.g. Göhlich 1999, Sen 2013). Within the phylogeny of Proboscideans (Fig. 1), **deinotheres** are included in a clade of mega herbivores together with other Elephantiformes (*Phiomia*, *Mammuth americanum*, *Gomphotherium* and Elephantidae) of which they are the sister group (Hutchinson et al. 2011). The differentiation between deinotheres and other mega proboscideans (Elephantiformes) could have occurred as early as the end of the Eocene. However, phylogenetic relationships within the Deinotheriidae family remain uncertain to this day.

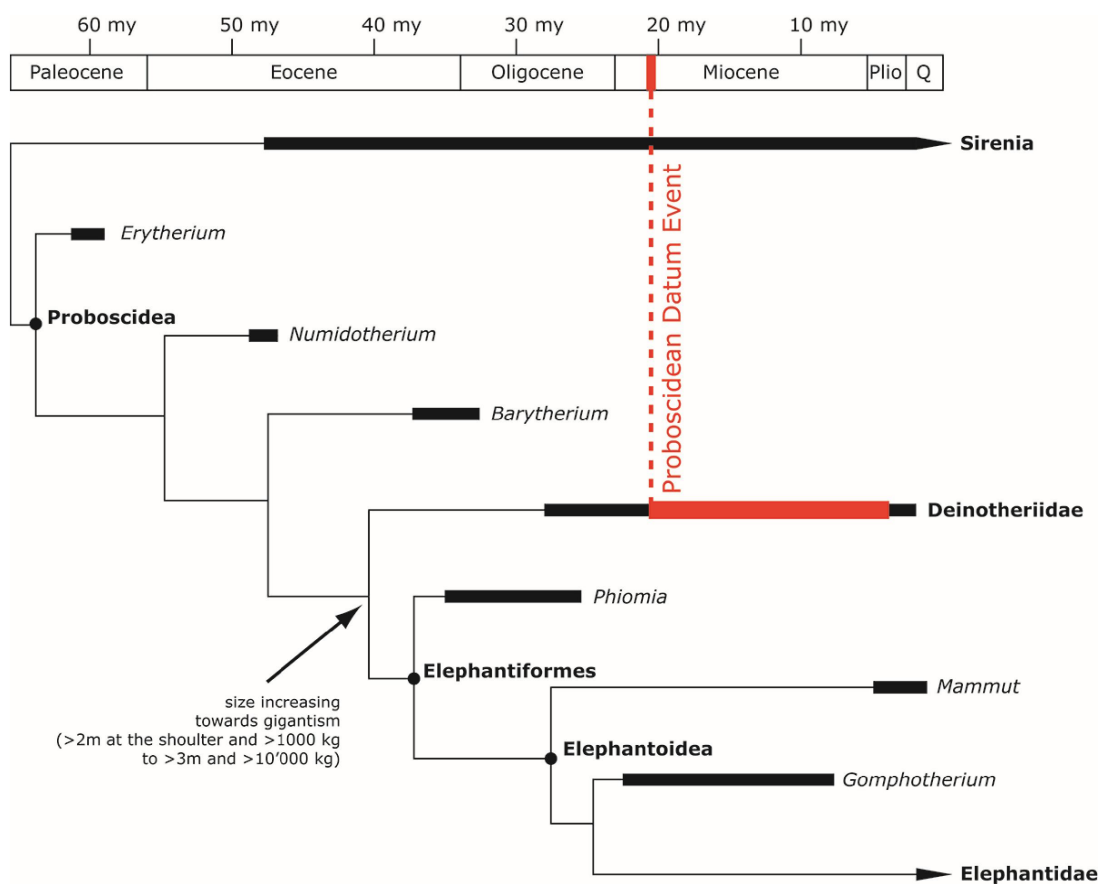
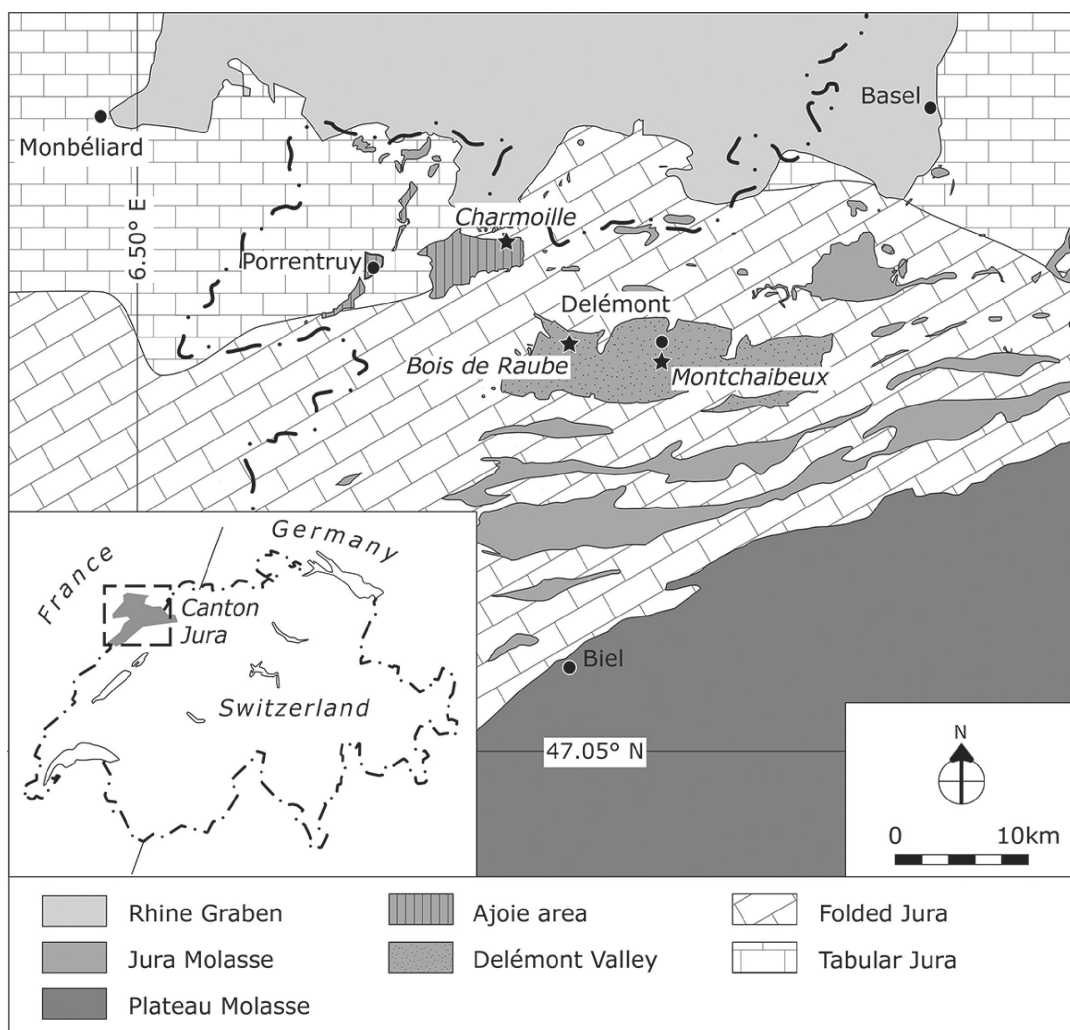

**Figure 1.** Simplified, stratigraphically calibrated, phylogeny of Proboscideans (modified from Hutchinson et al. 2011).

The oldest and most primitive there, *Chilgatherium harrisi* Sanders, Kappelman & Rasmussen, 2004, was discovered in Africa (Ethiopia) and is dated from the late Oligocene (Sanders et al. 2004). It disappeared slightly before the Miocene, probably replaced by *Prodeinotherium hobleyi* (Andrews, 1911) recorded in early Miocene of Uganda (Pickford 2003). After the *Proboscidean Datum Event* (ca. 19.5-17.5 Ma; late early Miocene), the distribution of the family extends to Asia with *Prodeinotherium pentapotamiae* (Falconer, 1868) discovered in Pakistan (Wellcome et al. 1997) and to Europe with *Prodeinotherium bavaricum* (von Meyer, 1831) from Lesvos and in Greece (MN3; Koufos et al. 2003) and *Prodeinotherium cuvieri* Kaup, 1832 in France and Spain (MN4; Azanza et al. 1993, Ginsburg & Chevrier 2001). The last there are still present in Asia by the late Miocene with *Deinotherium giganteum* Kaup, 1829 and *Deinotherium proavum* (Eichwald, 1835) (= *D. gigantissimum*, *D. indicum*) (Chaimanee et al. 2004, Rai 2004). In Africa, they persist with *Deinotherium bozasi* Arambourg, 1934 until the early Pleistocene (Harris 1983, Harris et al. 1988). In Europe, up to three species existed during the middle Miocene: *Prodeinotherium bavaricum*, *Deinotherium giganteum* and *Deinotherium levius* Jourdan, 1861 (e.g. Göhlich 1999, Ginsburg & Chevrier 2001, Pickford & Pourabrishami 2013). Additionally, Belyaeva (1948) reported a single occurrence of *Deinotherium proavum* at the end of the middle Miocene in Ukraine. In Eastern Europe, *Deinotherium giganteum* and *Deinotherium proavum* survived until the end of the late Miocene (Romania, Hungary and Bulgaria: Codrea et al. 2002, Kovachev & Nikolov 2006, Boev & Spassov 2009). From the Swiss Jura Mountains, Bachmann (1875) described a there mandible in five fragments, discovered in the west of the Montchaibeux by Jean-Baptiste Greppin in 1869, which he referred to *Deinotherium bavaricum*. Greppin (1867, 1870) reported the presence of a lower molar of *Deinotherium giganteum*, discovered by the geologist and naturalist Peter Merian in 1858, in the forest of Bois de Raube of the Delémont valley. there and gomphotheres were also found in Charmoille and successively reported by Stehlin (1914), Schäfer (1961) and Kälin (1993). However, none of the there remains from Charmoille have ever been described. Additionally, an isolated upper molar labelled *Deinotherium bavaricum* is housed in the Jurassica Museum collections. This specimen has never been reported before and its exact origin in the Delémont valley remains uncertain. This study focuses on the fossil remains of dinotheres discovered in the Swiss Jura Mountains in order to provide a complete description of the specimens and to update their identifications. A discussion on the distribution of dinotheres throughout the Miocene of Europe completes the article.

## Geographic, geologic and stratigraphic framework

The Jura Canton lies at the palaeogeographic junction between the Cenozoic tectonic and sedimentary provinces of the Upper Rhine Graben and the North Alpine Foreland Basin (Sissingh 2006). The regional fluvio-lacustrine sediments of the Miocene Bois de Raube Formation (OSM; Obere Süsswassermolasse = Upper freshwater molasses), were deposited both in Delémont Basin (near Delémont) and in Ajoie area (near Porrentruy). As Kälin (1997), this formation is subdivided into three members differing by a markedly different heavy mineral spectrum and pebble content: a basal Montchaibeux Member (“Rote Mergel und Dinotheriensande des Mont Chaibeux” of Liniger 1925), a middle conglomeratic Bois de Raube Member (“Vogesenschotter des Bois de Raube” of Liniger 1925) in Delémont Basin, and an upper Ajoie Member (“Hipparionsande von Charmoille” of Liniger 1925) in Delémont Basin, and an upper Ajoie Member (“Hipparionsande von Charmoille” of Liniger 1925). The formation covers the biochronological interval MN4 to MN9 (Kälin 1997, Choffat & Becker 2017, Prieto et al. 2017) and includes three historical localities that yielding there remains (Greppin 1867, 1870; Stehlin 1914; Schäfer 1961; Kälin 1993): Bois de Raube in Develier, Montchaibeux in Rossemaison and Charmoille in Ajoie (Fig. 2).



**Figure 2.** Geographic and geologic situation of the Swiss Jura localities (Montchaibeux, Bois de Raube and Charmoille) with Deinotheriidae remains.

## Material and meth

### Material

The studied material of Deinotheriidae, coming exclusively from in the Swiss Jura Canton, includes:

(1) the famous reconstituted mandible of *Prodeinotherium bavaricum* from the Montchaibeux locality (Bachmann 1975). A copy of this mandible is housed in the collections of the Jurassica Museum whereas the original specimen is housed in the collections Natural History Museum of Bern; (2) a copy of the lower molar of *Deinotherium giganteum* from the Bois de Raube locality (Greppin 1867, 1870), housed in the Jurassica Museum and whose the original seems to be housed in the Jean-Baptiste Greppin collection of Strasbourg University; (3) the upper molar of the Jurassica Museum collection of *Prodeinotherium bavaricum* coming probably from the Delémont valley; and (4) the specimens of Deinotheriidae from Charmoille (Stehlin 1914, Schäfer 1961, Kälin 1993, 1997, Choffat & Becker 2017) which consists in some fragments of tusks from the Jurassica Museum collection and more complete dental specimens housed in the Museum of Natural History of Basel.

### Terminology and measurements

The dental terminology for Deinotheriidae mainly follows that of Aiglstorfer et al. (2014) and Pickford & Pourabrishami (2013) (Fig. 3), and is illustrated in this paper for a better understanding of the characters descriptions and discussions. The measurements written in the tables or in the text are given in millimetres (precision at 0.1 mm), those in brackets are estimated.

### Systematic

The systematic Deinotheriidae is still unclear as there is no consensus in the literature about the exact number of valid genera and species. Éhik (1930) proposed two genera to refer to all European species, *Prodeinotherium* and *Deinotherium*. In contrast, some authors (e.g. Böhme et al. 2012, Pickford & Pourabrishami 2013) state that all European species should be referred to *Deinotherium*, considering *Prodeinotherium* junior synonym. Other authors (Huttunen (2002a) and Duranthon et al. (2017) provided further arguments supporting the existence of the two genera based on morphological and morphometrical features. Following Aiglstorfer et al. (2014), who also recognised both genera, five European species are considered to be valid in this work: *Prodeinotherium cuvieri* Kaup, 1832, *Prodeinotherium bavaricum* (von Meyer, 1831), *Deinotherium*

*levius* Jourdan, 1861, *Deinotherium giganteum* Kaup, 1829 and *Deinotherium proavum* (Eichwald, 1835).

**upper check teeth**

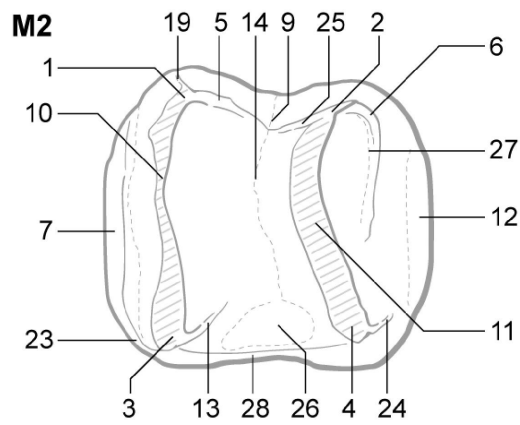
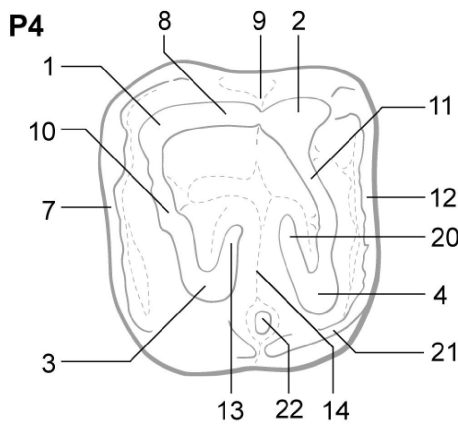
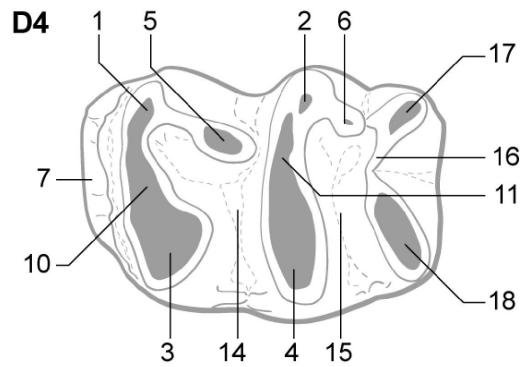

**lower check teeth**

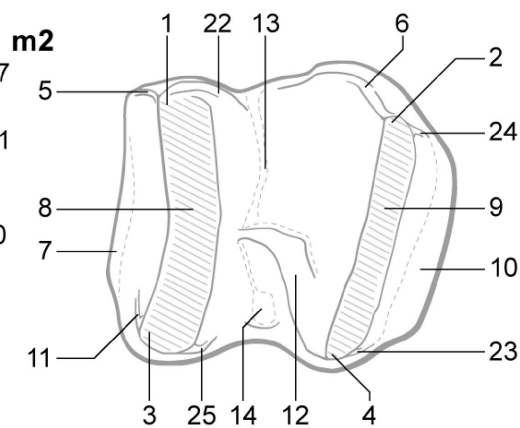
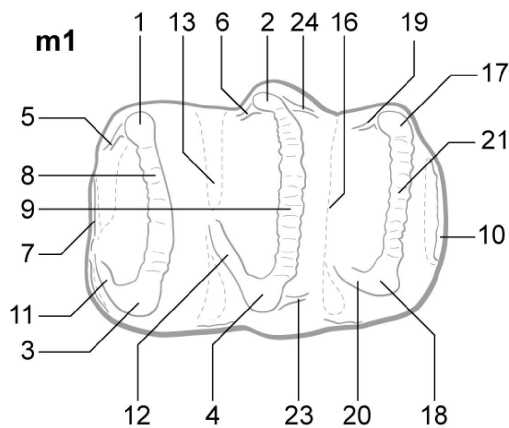
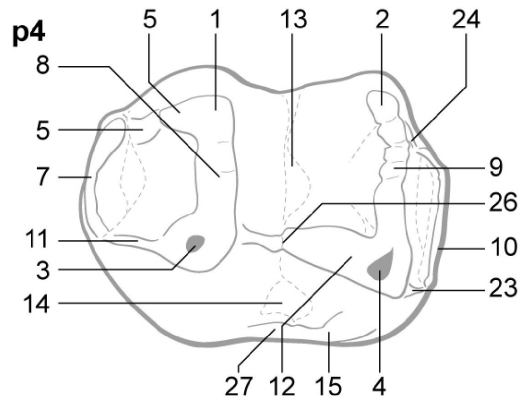
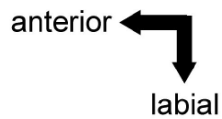

**Figure 3.** Dental terminology of upper and lower cheek teeth of Deinotheriidae in occlusal views (not to scale), mainly following Aiglstorfer and al. (2014) and Pickford & Pourabrishami (2013). **Upper cheek teeth:** 1, paracone; 2, metacone; 3, protocone; 4, hypocone; 5, postparacrista; 6, postmetacrista; 7, anterior cingulum; 8, ectoloph; 9, ectoflexus; 10, protoloph; 11, metaloph; 12, posterior cingulum; 13, postprotocrista; 14, median valley; 15, distal valley; 16, tritoloph; 17, labial tritoloph cone; 18, lingual tritoloph cone; 19, paraacrista; 20, praehypocrista; 21, lingual cingulum; 22, entostyle (mesostyle of Harris 1973); 23, praeprotocrista; 24, posthypocrista; 25, praemetacrista; 26, lingual medifossette; 27, convolute; 28, lingual cingulum. **Lower cheek teeth:** 1, metaconid; 2, entoconid; 3, protoconid; 4, hypoconid; 5, praemetacristid; 6, praeentocristid; 7, anterior cingulid; 8, metalophid; 9, hypolophid; 10, posterior cingulid; 11, praeprotocristid; 12, praehypocristid; 13, median valley; 14, lingual medifossette; 15, labial cingulid; 16, distal valley; 17, lingual tritolophid conid; 18, labial tritolophid conid; 19, anterior cristid of the lingual tritolophid conid; 20, anterior cristid of the labial tritolophid conid; 21, tritolophid; 22, postmetacristid; 23, posthypocristid; 24, postentocristid; 25, postprotocristid; 26, lingual notch; 27, labial cingulid

### Stratigraphy and fossil record

The stratigraphical framework used in this study is based on the global geological time scale for the Neogene (Hilgen et al. 2012), the European Mammal Neogene units (MN-Zones; Mein 1999, Steininger 1999), and the Swiss fauna references (Engesser & Mödden 1997, Berger 2011).

The data set of the fossil record of the European Deinotheriidae is a compilation of the localities reported in Maridet & Coster (2010), The Paleobiology Data Base (extraction the 25.07.2019 with the parameter family = Deinotheriidae) and additional literature (Appendix 1). In order to highlight the palaeobiogeographic dynamics of deinotheriids' distribution in Europe, localities are grouped by the biochronological intervals MN4-5, MN6-8, MN9-12 and MN13-14, and biogeographic events (Proboscidean Datum Event, Hipparion Datum Event) and major climate changes (Miocene Climatic Optimum, Mid-Miocene Cooling Event, Messinian Crisis) are taken into account. The biostratigraphical context of each locality was systematically checked in the literature and questionable data were removed from the data set.

### Abbreviations

**APD** anteroposterior diameter, **dex.** right, **H** height, **i** lower incisors, **L** lower molar, **m/M** lower and upper molars, **MJSN** Jurassica Museum (formerly Musée jurassien des Science naturelles), **MN** Mammal



Neogene, **NMB** Naturhistorisches Museum Basel, **NMBE** Naturhistorisches Museum Bern, **p/P** lower and upper premolars, **sin.** left., **TD** transverse diameter, **W** width.

## Systematic

Class MAMMALIA Linnaeus, 1758

**Order PROBOSCIDEA Illiger, 1811**

Family Deinotheriidae Bonaparte, 1845

Genre *Prodeinotherium* Ehik, 1930

European species: *Prodeinotherium bavaricum* (von Meyer, 1831), *P. cuvieri* Kaup, 1832.

### ***Prodeinotherium bavaricum* (von Meyer, 1831)**

(Figs. 4-5; Tab. 1-3)

#### **Stratigraphical range**

Late early Miocene to early late Miocene, MN4-9 (Göhlich 1999).

#### **Material referred**

M2 dex. (MJSN-VDL-001) from the Delémont valley (unknown locality); P4 dex. (NMB-Mch.4, copy MJSN-MTC-001) and mandible with i2 and p4-m3 (original NMBE-5031977, copy MJSN-MTC-002) from Montchaibeux.



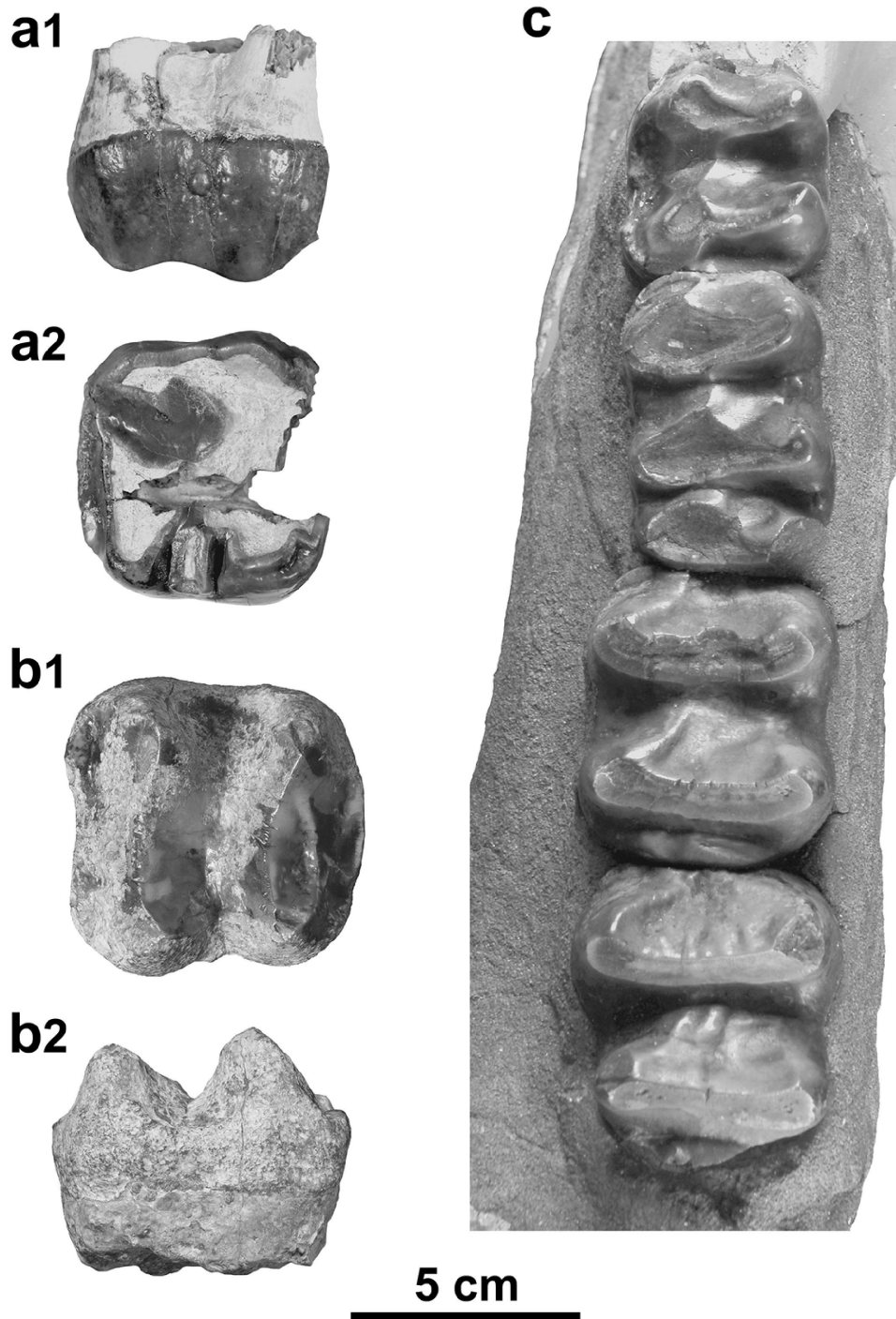

**Figure 4.** *Prodeinotherium bavaricum* of the Delémont valley (Jura, Switzerland). **a**, P4 dex. (NMB-Mch.4, Montchaibeux locality) in lateral (a1) and occlusal (a2) views; **b**, M2 dex. (MJSN-VDL-001, unknown locality) in occlusal (b1) and lateral (b2) views; **c**, p4-in. (NMBE-5031977, Montchaibeux locality) in occlusal view. Scale bar = 5 cm.

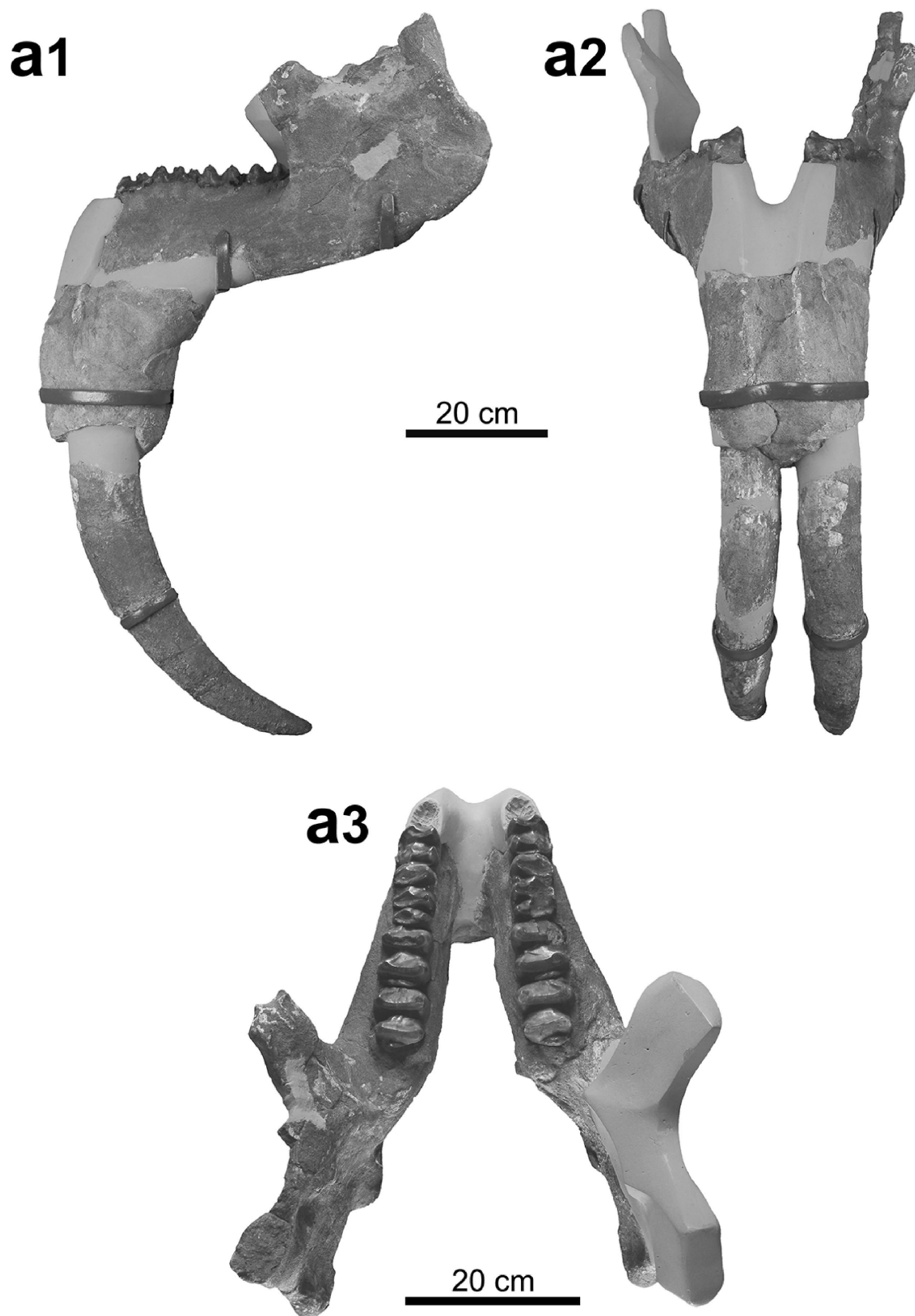

**Figure 5.** *Prodeinotherium bavaricum* of Montchaibeux (Jura, Switzerland). **a**, Mandible (NMBE-5031977) in lateral view (a1), in anterior view (a2) and in occlusal view (a3). Scale bar = 20 cm.

Specimens	Length	Width		Height
		protoloph	metaloph	
NMB-Mch.4 (P4)	53.9	58.5	56.1	28.8
MJSN-VDL-001 (M2)	66.5	65.6	62.2	35.0
NMB-D.G.5 (M2)	61.8	64.2	66.7	-
NMB-Fa.129 (M2)	64.3	68.3	61.2	-
NMB-Fa.167 (M2)	71.8	70.5	70.9	-

**Table 1.** Dimensions [mm] of P4 and M2 of *Prodeinotherium bavaricum* (NMB-Mch.4, Montchaibeux, MN4-6; NMB-D.G.5, Haute Garonne of Aurignac, middle Miocene; NMB-Fa.129, NMB Fa.167, Pontlevoy-Thenay, MN5).

Measurements	Sin.	Dex.
Height of the mandibular ramus	260.0	-
Length of tooth 	290.0	290.0
Height of mandibular body at m2 and m3	155.0 ; 165.0	135.0 ; 165.0
Width of mandibular body at p4, m1, m2 and m3	90.0 ; 95.0 ; 105.0 ; 120.0	90.0 ; 100.0 ; 115.0 ; 130.0
Length of the mandibular ramus	26.0	-

**Table 2.** Dimensions [mm] of the mandible of *Prodeinotherium bavaricum* (NMBE-5031977) of Montchaibeux (Jura, Switzerland, MN4-6).

Incisors	Antero-posterior diameter	Transversal diameter			Length
i2 sin. (tusk)	285.0	120.0			535.0
i2 dex. (tusk)	285.0	130.0			475.0

Clique teeth	Length	Width			Height
		metalophid	hypolophid	tritilophid	
p4 sin.	53.1	43.4	46.4	-	29.5
p4 dex.	50.9	44.7	46.3	-	30.4
m1 sin.	67.0	44.3	44.9	41.9	22.7
m1 dex.	69.5	46.7	47.4	48.8	31.2
m2 sin.	61.9	55.3	55.7	-	30.2
m2 dex.	64.9	(58.5)	59.0	-	33.5
m3 sin.	64.3	56.8	50.7	-	27.7
m3 dex.	68.2	64.7	53.1	-	33.5

**Table 3.** Dimensions [mm] of the teeth of the mandible *Prodeinotherium bavaricum* (NMBE-5031977) of Montchaibeux (Jura, Switzerland, MN4-6).

### Description

The P4 is damaged anteriorly and moderately worn. It is nearly quadratic in occlusal view, just slightly wider than long. The ectoloph is complete bearing an ectoflexus weakly developed, and distinct paracone fold, mesostyle (intermediate fold) and metacone fold, the former being the most developed. The protocone seems to extend laterally, forming a complete protoloph reaching the paracone. The hypocone is laterally elongated but does not form a complete metaloph connecting to the metacone, giving a sublophodont morphology to the tooth. The cingulum is posteriorly pronounced but anteriorly unobservable. The lingual one is absent whereas the lingual one is strong but only present at the level of the protocone. The lingual opening of the median valley bears a well-developed entostyle. Three roots are present; the unique lingual one results from the fusion of two roots.

The M2 is bilophodont and subquadrate in occlusal view. The protoloph and metaloph are complete, both with almost the same width, anteriorly convex (with a more pronounced convexity on the metaloph) and have anterior wear facets. The four main cusps are distinct from the lophs. The postparacrista is well marked and slopes to the median valley that is opened on the lingual side. The postprotocrista is less developed and does not extend downward to the medial valley. The praeprocrista and the posthypocrista are not marked. The praemetacrista is well pronounced,

slopes to the median valley and joins the postparacrista. Posteriorly, the convolute is well developed. The anterior and posterior cingula are strong and continuous, although the anterior one is thinner in its middle part. The lingual cingulum is less pronounced but closes the lingual medifossette. The lingual side of the tooth lacks any cingulum, but it is characterised by a deep ectoflexus.

The mandible NMBE-5031977, restored from 5 fragments, is incomplete. The ramus is low and slightly inclined forward, the mandibular angle forms a right dihedral, the base of the corpus is straight, and the posterior margin of the symphysis is located below the front of the p4. The i2 are oriented downward and slightly curved backwards in their distal parts. The toothrows are almost complete from p4 to m3, the p4s being anteriorly incomplete and the p3s not preserved. The m1s are trilophodont and the other lower cheek teeth are bilophodont. The transverse lophids are subparallel, posteriorly convex for the anterior ones to straight for the posterior ones, and possess wear facets posteriorly oriented.

In occlusal view, the p4 is rectangular, longer than wide. The paracristid is not preserved, the metalophid is posteriorly convex and the hypolophid is almost straight. The ectolophid is poorly developed and directed anterolingually to reach the median valley. The lingual cingulid is reduced to the posterior part of the tooth, the lingual one is lacking. The posterior cingulid is well developed, continuous and low but merging with a weak posthypocristid.

The rectangular m1 is trilophodont, with sub-parallel, roughly straight and of equally wide transverse lophids. The praeprotocristid, the praehypocristid and the anterior cristid of the lingual tritolophid conid are all well pronounced, the latter two reaching the bottom of the respective front valleys. The anterior and posterior cingulids are poorly developed whereas the labial and lingual ones are lacking. The m2 is sub-rectangular in occlusal view, slightly longer than wide, with equally wide transverse lophids. The metalophid is posteriorly slightly convex and the hypolophid is straight. The praeprotocristid and the praehypocristid are well developed and anterolingually oriented, the former reaching the bottom of the median valley. The anterior and posterior cingulids are continuous, the posterior one being stronger. The lingual and labial cingulids are lacking.

The m3 is morphologically similar to the m2. However, the hypolophid is slightly reduced in width compared to the metalophid and the posterior cingulid is more pronounced but strongly reduced in width, giving a longer and trapezoidal outline in occlusal view.

## Comparisons

The referred dental remains are typical from the Deinotheriidae family with mainly bilophodont jugal teeth associated to a sublophodont (well-developed ectoloph and incomplete metaloph) P4 and a trilophodont m1, as well as i2 oriented downwards and backwards (Huttunen 2002a).

The specimens differentiate from *Deinotherium proavum* and *D. giganteum* species by considerably smaller dimensions (Gräf 1957, Vergiev & Markov 2010, Pickford & Pourabrishami 2013, Aiglstorfer et al. 2014, Țibuleac 2018). *Deinotherium levius* presents bigger dimensions, but the differences are less significant (Gräf 1957, Pickford & Pourabrishami 2013). However, the strong development of the convolute and the near absence of postprotocrista and posthypocrista on the M2 clearly exclude an attribution to the *Deinotherium* genus (Harris 1973, Huttunen 2002b, Poulakakis et al. 2005, Duranthon et al. 2007, Aiglstorfer et al. 2014). Likewise the moderately developed curve of the i2 can be distinguished from the more pronounced one of *D. giganteum* and the subvertical one of *D. levius* (Gräf 1957).

Although, in *Prodeinotherium*, the entostyle is usually lacking on P3-4 and the metaloph usually complete on P4, these particular characters, present on the referred P4 NMB-Mch.4, can be attributed to generic variability (e.g. Harris 1973, Ginsburg & Chevrier 2001, Aiglstorfer et al. 2014). Also by its dimensions the almost absence of an ectoflexus and the quadratic outline in occlusal view, this specimen shows strong similarities with *Prodeinotherium* species, particularly of *P. bavaricum* (Ginsburg & Chevrier 2001, Duranthon et al. 2007, Pickford & Pourabrishami 2013). Based on the morphology of the P4 (nearly absence of ectoflexus and the quadratic outline), the M2 (developed convolute) and the lower cheek teeth (m1 with transverse lophids roughly straight and of equal width), as well as the modest curve of the i2, the specimens can be referred to the genus *Prodeinotherium* (Gräf 1957, Harris 1973, Huttunen 2002a, Huttunen & Göhlich 2002, Duranthon et al. 2007). Additionally, after Ginsburg & Chevrier (2001) and Pickford & Pourabrishami (2013), the specimens cannot be referred to the species *P. cuvieri* due to their larger dimensions, but rather to *P. bavaricum* of which they are much closer (e.g. Gräf 1957, Kovachev & Nikolov 2006, Huttunen & Göhlich 2002).

#### Genre *Deinotherium* Kaup, 1829

European species: *Deinotherium giganteum* Kaup, 1829, *D. proavum* (Eichwald, 1835), *D. levius* Jourdan, 1861.

#### ***Deinotherium levius* Jourdan, 1861**

(Fig. 6; Tab. 4)

#### **Stratigraphical range**

Middle to early late Miocene MN6-9 (Codrea et al. 2007).



### Material referred

Distal fragment of a right incisor (NMB-Cm.478), D4 dex. (NMB-Cm.245, copy MJSN-CH-060), P4 dex. (NMB-Cm-96, copy MJSN-CH-062), p4 dex. (NMB-Cm.469, copy MJSN-CH-058), m1 dex. (NMB-Cm.466, copy MJSN-CH-059) and m2 dex. (NMB-Cm.737, copy MJSN-CH-061) from Charmoille in Ajoie.

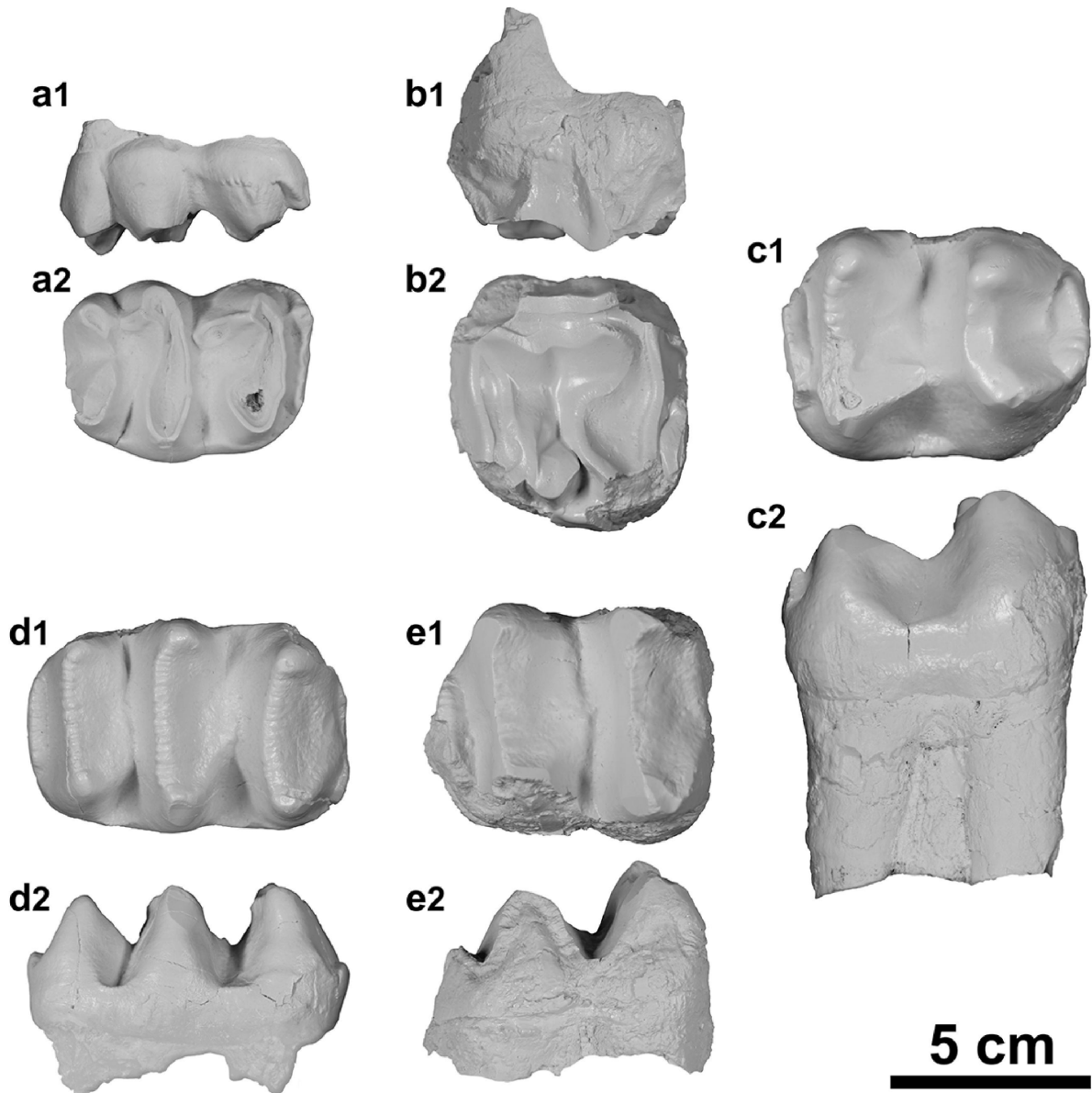

**Figure 6.** *Deinotherium levius* of Charmoille (Jura, Switzerland). **a**, D4 dex. (copy MJSN-CH-060 of NMB-Cm.245,) in lateral (a1) and occlusal (a2) views; **b**, P4 dex. (copy MJSN-CH-062 of NMB-Cm-96,) in lateral (b1) and occlusal (b2) views; **c**, p4 dex. (copy MJSN-CH-058 of NMB-Cm.469,) in occlusal (c1) and lateral (c2) views; **d**, m1 dex. (copy MJSN-CH-059 of NMB-Cm.466,) in occlusal (d1) and lateral (d2) views; **e**, m2 dex. (copy MJSN-CH-061 of NMB-Cm.737,) in occlusal (e1) and lateral (e2) views. For better illustration quality, white copies have been photographed. Scale bar = 5 cm.



Upper check teeth	Length	Width		Height
		protoloph	metaloph	
MJSN-Cm.245 (D4)	65.9	46.4	48.8	27.1
NMB-Cm.96 (P4)	(59.9)	(65.1)	(62.4)	37.7
Lower check teeth	Length	Width		Height
		metalophid	hypolophid	
MJSN-Cm.469 (p4)	71.8	56.5	56.2	49.5
MJSN-Cm.466 (m1)	84.5	55.1	57.2	36.5
MJSN-Cm.737 (m2)	(73.2)	(63.6)	(61.1)	40.7





**Table 4.** Dimensions [mm] of the dental specimens of *Deinotherium levius* from Charmoille (Jura, Switzerland, MN9).



### Description



The fragmented incisor NMB-Cm.478 is roughly oval in transverse section, with a longest axis in anteroposterior direction, the diameter diminishing distally and a flattened medial side. The distal curvature, caudally and laterally, is weakly developed. The specimen shows wear facets on the distal side and at the tip.

The D4 is trilophodont and elongated. The protoloph is anteriorly convex and the metaloph is nearly straight. The tritoloph is anteriorly strongly convex and incomplete, the lingual and lateral cones are separated by a notch. The postparacrista and the postmetacrista are weakly developed, extending posterolingually downward and reaching the buccal loph. The anterior and posterior cingula are present, the anterior one being strongly pronounced and connected to the paracone by a faint crista. The transverse valleys are lingually faintly closed by a reduced lingual cingulum. The lateral cingulum is almost completely lacking, only faint lateral rugosities are observable at the level of the paracone.

The P4 is moderately worn, incomplete (enamel only partly preserved around the outline of the crown), slightly wider than long and trapezoidal in occlusal view. The ectoflexus is very smooth and the mesostyle barely distinct. The protoloph is complete, reaching the paracone, whereas the metaloph is in contact with the metacone but not fused with it. The hypocone extends labially downward by a preprotocrista. The cingulum is labially absent, is anteriorly and posteriorly strong and complete, and is labially reduced to the opening of median valley. The latter bears a strong entostyle in contact with the hypocone but separated from the protocone. The two lingual roots are isolated and the two lingual ones are in contact, just separated by a vertical groove.

The p4 is almost bilophodont with neral outline longer than wide. An ectolophid extends anterolingually downward from the hypoconulid, reaching the base of the metalophid. The metalophid is anteriorly concave, the hypolophid is roughly straight. The paracristid extends anteriolingually downward from the paraconid and connects a very strong anterior cingulid. The praeacristid extends anteriorly downward, almost closing an anterior valley-like groove. The posterior cingulid is well developed and connected to the hypoconulid by a very faint posthypocristid. The lingual cingulid is lacking and the one is reduced to the base of the notch, closing a medifossette.

The m1 is trilophodont and elongated. Each conid has a slightly pronounced anterior cristid. The praecristid is the most developed. It extends anteriolingually downward, reaching the anterior valley and reaching the metalophid. The anterior cingulid is poorly developed whereas the posterior one re developed. The transverse valleys are open on both sides, although reduced  cingulids are present at the extremities of these valleys.

The m2 is bilophodont and nearly rectangular (slightly longer than wide). The anterior cingulid is unobservable whereas the posterior one is low and strong but narrower than the hypolophid. The median valley is opened on both sides, without l and lingual cingulids. Each conid has a slightly developed and anteriorly extending cristid, except the praecristid which extends anterolingually and reaches the bottom of the median valley.

## Comparisons

The specimens from Charmoille show the typical features of Deinotheriidae: lower tusks oriented downward, P4 bearing an ectoloph, trilophodont D4 and m1, and a bilophodont pattern for the remainder of the cheek teeth (Huttunen 2002a). They differ from *Prodeinotherium* by being larger, by a trapezoidal outline and a more distinct ectoflexus in P4, as well as a narrower tritolophid compared to other lophids in m1 (Gräf 1957, Ginsburg & Chevrier 2001, Duranthon et al. 2007). Among the *Deinotherium* species, they display more affinities with *D. levius* by the size (slightly smaller than those of *D. giganteum*, Pickford & Pourabrishami 2013), by a subcomplete metaloph without a notch separating it from the metacone and the presence of a strong entostyle on P4, by a protolophid and metalophid of equal lengths in p4 (rectangular outline vs trapezoidal outline in *D. giganteum*), and by a short posterior cingulid on m2 (Gräf 1957, Duranthon et al. 2007). This attribution also seems to be supported by the i2 NMB-Cm478 that displays a sub-straight tusk tip, characteristic of *D. levius* according to Gräf (1957).

## *Deinotherium giganteum* Kaup, 1829

(Fig. 7; Tab. 5)



### Stratigraphical range

Middle to late Miocene MN6-12(-14) (Codrea and al. 2007).

### Material referred

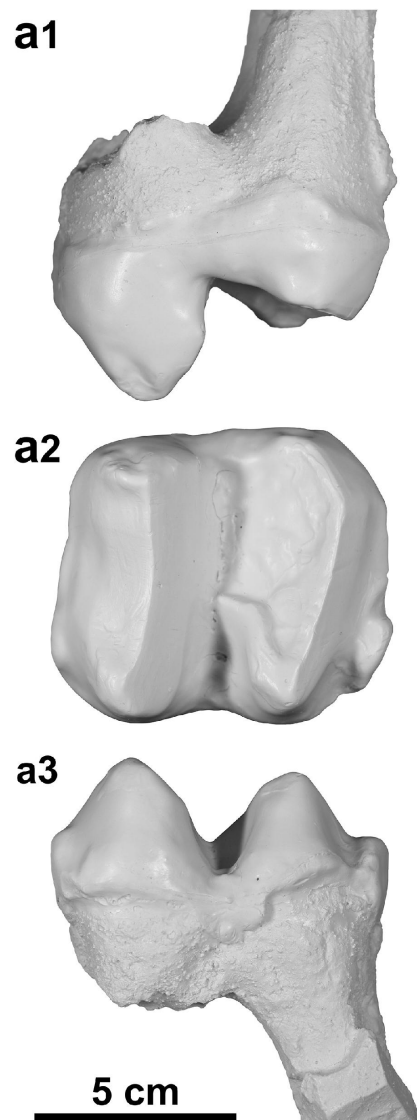
Complete m2 sin. (copy MJSN-BRA-001; original in the Jean-Baptiste Greppin collection at the Strasbourg university) from the Bois de Raube locality in the Delémont valley.



**Figure 7.** *Deinotherium giganteum* of Bois de Raube in the Delémont valley (Jura, Switzerland). **a**, m2 sin. (copy MJSN-BRA-001) in occ  lingual (a1), occlusal (a2) and  (a3) views. For better illustration quality, white copy has been photographed. Scale bar = 5 cm.

Specimens	Length	Width		Height
		metalophid	hypolophid	
MJSN-BRA-001	82.6	72.1	75.2	40.0
NMB-Ep.16	81.9	77.2	75.6	-
NMB-Ep.135	88.1	75.5	70.5	-

**Table 5.** Dimensions [mm] of m2 of *Deinotherium giganteum* (copy MJSN-BRA-001, Bois de Raube, Jura, Switzerland, MN6-7/8; NMB-Ep.16, NMB-Ep.135, Eppelsheim, Germany, MN9)

### Description

The referred m2 is bilophodont and slightly longer than wide in occlusal view. The four main cuspids are distinct. The transverse lophids are complete, separated by a **l** deeper median valley, and have posteriorly wear facets. The hypolophid is sublinear and slightly wider than the metalophid. The metalophid is anteriorly weakly concave. The protoconid and the metaconid are quite sharp and equally high. The **p** and postprotocristid are hardly distinct, the **m** and postmetacristid are more prominent but blunt. The entoconid is very smooth, difficult to distinguish and lower than the metaconid. The **p** protocristid is quite well marked, very rounded, and **d** almost to the level of the median valley. The postentocristid is barely visible. The hypoconid, quite salient at the top, is slightly more modest than the protoconid. The **h** hypocristid, really robust and smooth, forms a thick enamel bulge that **d** transversally to the median valley level and almost reaches the middle of the tooth. The posthypocristid is very weak, almost indistinct. There is no particular ornamentation on the tooth. However, the presence of a strong posterior cingulid, incomplete on the **l** side, of a weak anterior cingulid, slightly more pronounced **l**ly, and of a **l** medifossette barely delimited by a modest enamel bridge are noticeable.

### Comparisons

The m2 displays a bilophodont pattern with a well-developed posterior cingulid which are typical of the Deinotheriidae family (Huttunen 2020a). This m2 can be differentiated from m2s of *Prodeinotherium* by their sizes that are on average up to more than 30% larger than those of *P. cuvieri* and about 20% larger than those of *P. bavaricum* (e.g. Gräf 1957, Ginsburg & Chevrier 2001, Huttunen & Göhlich 2002, Pickford & Pourabrishami 2013). In addition, the **h** hypocristid is remarkably more developed than in *P. bavaricum* (as is the posterior cingulid too), then the tooth can be undoubtedly referred to the genus *Deinotherium* (e.g. Huttunen 2002a, b, Huttunen & Göhlich 2002, Duranthon and al. 2007, Ţibuleac 2018).

A specific identification within the genus *Deinotherium* remains very difficult based on morphological characters whereas only evolutionary trends seem to be observable along time (e.g. Gräf 1957, Ginsburg & Chevrier 2001, Duranthon et al. 2007, Pickford & Pourabrishami 2013). However, Pickford & Pourabrishami (2013) suggest specific attributions by highlighting, contrary to Gräf (1957), discontinuous size ranges from one species to another. Based on these observations, m2s of *D. proavum* are always larger than 90 mm and can exceed 100 mm, which unambiguously excludes our specimen from Bois de Raube whose length is 82.6 mm (Tab. 5). *Deinotherium levius*, with m2 lengths between 69.2 and 77.0 mm, is noticeably smaller. The m2 of Bois de Raube (MJSN-BRA-001) falls within the size range of *D. giganteum*, between 79.0 and 89.3 mm. Moreover, the degree of development of the posterior cingulid shows a very close similarity to m2 of *D. giganteum* from Eppelsheim (NMB-Ep.16, NMB-Ep.135) and from Romania (Țibuleac 2018). For these reasons, we tentatively refer this unknown tooth to *D. giganteum*.

## Discussion

### Fossil record of Deinotheriidae in the Jura

The age of the cingulid teeth discovered in the Swiss Jura Mountains is based on the regional litho- and biostratigraphy established by Kälin (1993, 1997) and Prieto et al. (2017) and fits the biostratigraphic range of the species at the European scale. The records correlate to MN4-6(-7) for *P. bavaricum* in Montchaibeux, to MN6-7/8 for *D. giganteum* in Bois de Raube and to MN9 for *D. levius* in Charmoille. The latter record indicates the first report of *D. levius* in Switzerland and matches the latest occurrences of this species in Europe (Fig. 8).

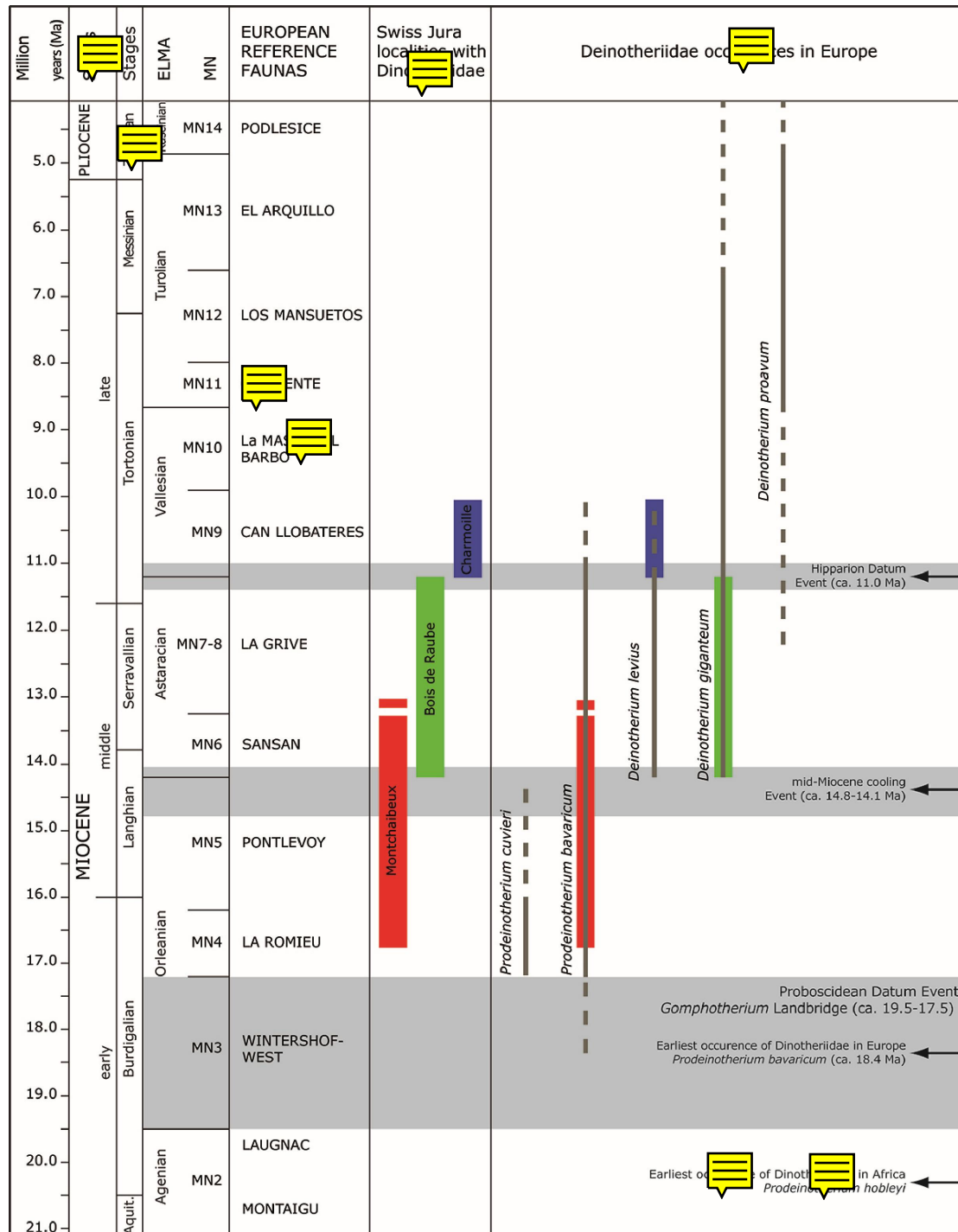

**Figure 8.** Stratigraphic extension of five species of European Deinotheriidae (*P. cuvieri*, *P. bavaricum*, *D. levius*, *D. giganteum* and *D. proavum*). The dashed lines represent enlarged occurrences for each species, supported by the fossil record of the appendix 1. The correlations with the European fauna of reference are according to Berger (2011) and the ones with the regional lithostratigraphy to Kälin (1993, 1997) and Prieto et al. (2017).

### Biogeographic distribution of European Deinotheriidae

The deinotheres known since the late Oligocene in Africa arrived later in Eurasia, following the mid-Burdigalian Proboscidean Datum Event (ca. 19.5-17.5 Ma). This event is related to the terrestrial corridor, called the *Gomphotherium* Landbridge, allowing a faunal exchange between Eurasia and the Arabian Plate of which the proboscideans were the palaeontological index fossils (Tassy 1990, Göhlich 1999, Rögl 1999a, b, Koufos et al. 2003). Although the first, short-lasting migration corridors evolved already during the Aquitanian or perhaps earlier in Asia (e.g. Tassy 1990, Antoine et al. 2003), the main wave of migration of the *Gomphotherium* Landbridge started during the mid-Burdigalian in Europe, with the arrivals of the earliest gomphotheres, deinotheres and mammutids at the end of MN3 (Tassy 1990, Koufos et al. 2003). Among the early occurrences of European deinotheres in MN3-4, *Prodeinotherium cuvieri* is endemic to the west of Europe (France and Spain) while *P. bavaricum* presents a more balanced distribution all over Europe (Fig. 9). This period corresponds to the Miocene Climatic Optimum (ca. 17.0-15.0 Ma) when a tropical forest covered most of Europe with an average annual temperature that could reach 20-22°C and a more marked seasonality (nearly six months of drought; Böhme 2003).

In the MN6-8 interval, a fast climatic deterioration, in the form of an important fall of the temperature (Mid-Miocene Cooling Event, ca. 14.8-14.1 Ma; Flower & Kennett 1994), coincides with the arrival of bigger deinotheres like *D. levius* and *D. giganteum* and to a lesser degree *D. proavum* in Eastern Europe only. With the persistence of *P. bavaricum*, three taxa coexist, but *P. bavaricum* and *D. giganteum* clearly dominate the communities of deinotheres. The single and earliest occurrence of *D. proavum* in Ukraine (Belyaeva 1948) does not allow highlighting a sympatry of the four species, but could be an evidence for an early adaptation of this mega deinotheres. From a climatic and environmental perspective, this period is also characterised by the sea level rise in the east of Europe and the oriental regions of the Mediterranean (Eronen et al. 2010). The average annual temperature drops at least of 7°C to settle between 15.4°C and 14.8°C mean annual temperatures. Meanwhile, the minimal temperatures for the coldest months go down more than 11°C inducing freezing temperature during winters. This climatic deterioration also contributes to settle more contrasted climatic zones across Europe (Böhme 2003).

After the *Hipparion Datum Event* (ca. 11.0 Ma), i.e. arrival in Europe of the little tridactyl horse from northern America (*Hippotherium primigenium*) in whole Holarctic regions (McFadden 1992), the deinotheres are essentially dominated by larger species *D. giganteum* and *D. proavum*, although some rare occurrences of *P. bavaricum* and *D. levius* are still reported in occidental Europe. The distribution of *D. proavum* is limited to Eastern Europe, except for an occurrence at Dorn-Dürkheim in the Mainz basin (Pickford & Pourabrishami 2013). The occurrence of *Deinotherium* is also



confirmed in India at the time with *D. indicum* (recently synonymised with *D. proavum*) in the north west of the Siwaliks (Sankhyan & Sharma 2014). *Deinotherium giganteum* is more cosmopolitan at European scale and also spreads into the Middle East (Mirzaie Ataabadi et al. 2011).

Finally, during the MN13-14 interval, corresponding to the Messinian Crisis (ca. 6.0-5.0 Ma) and the extension of the open forests in the temperate latitudes of Eurasia (Vislobokova & Sotnikova 2001, Rouchy and al. 2006), only the two largest species (*D. giganteum* and *D. proavum*) subsist in Eastern Europe.

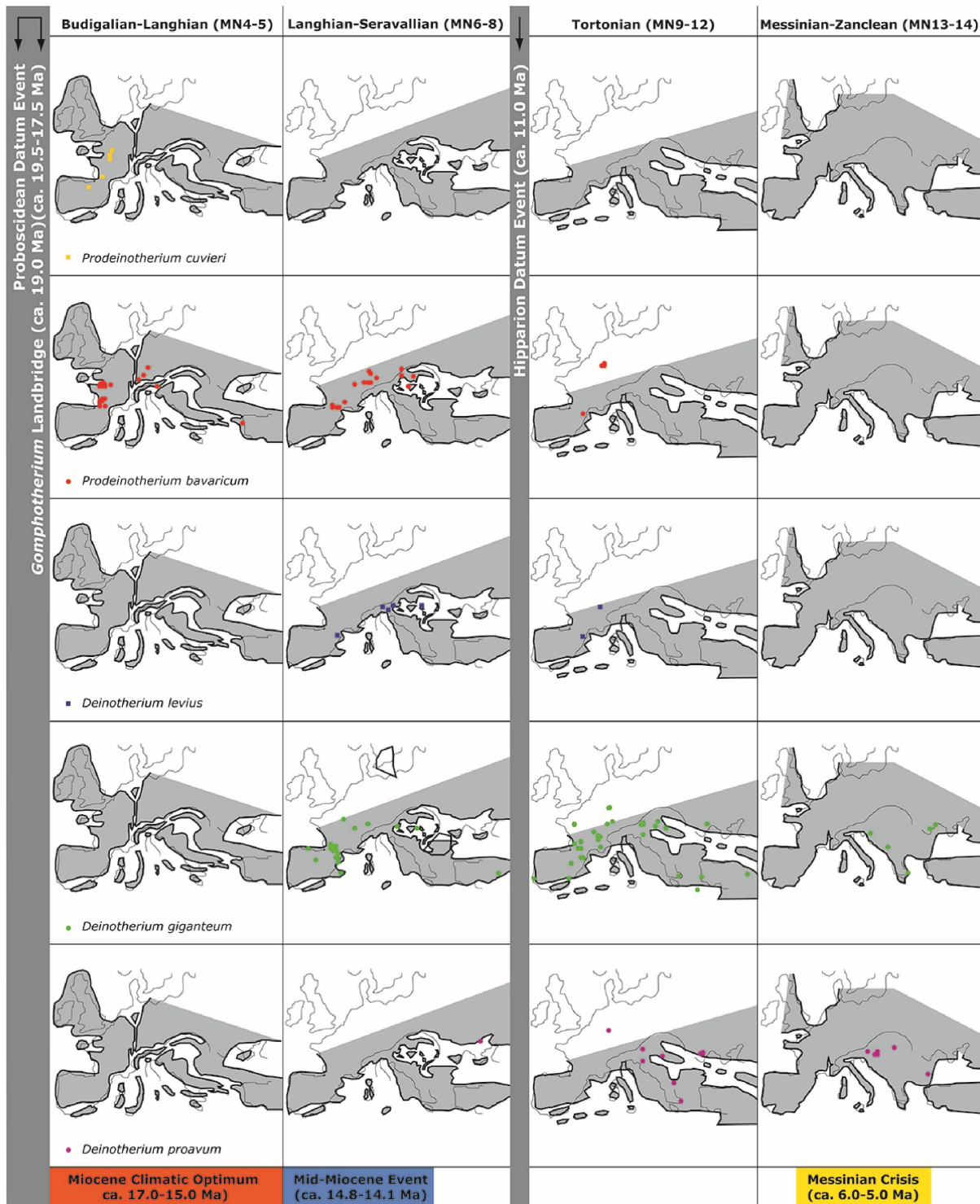

**Figure 9.** Paleogeographic distribution of the five Deinotheriidae species in Europe (*Prodeinotherium cuvieri*, *P. bavaricum*, *Deinotherium levius*, *D. giganteum*, *D. proavum*), according to the localities written in appendix 1.

## Morphologic evolution and ecology of the Deinotheriidae

Teeth of Deinotheriidae show a remarkable increase of their dimensions throughout their evolution (Pickford & Pourabrishami 2013) which reflects an evolution toward larger size for the whole family (Aiglstorfer et al. 2014, Codrea & Margin 2009). According to Agustí & Antón (2002), the *Prodeinotherium* were 2 m tall at the shoulder, while *Deinotherium* might have reached 4 m. Some species of Deinotheriidae presented body mass far greater than those of extant elephants. For comparison, the heaviest record of an African elephant weight is of 6.64 t (Larramendi 2016), whereas the average in general includes between 4 and 5 t. The most ancestral ones, *Chilgatherium harrisi*, weighed already 1.5 tonnes (Sanders et al. 2004), *Prodeinotherium bavaricum* and *P. hobleyi* weighed nearly 4 tonnes, *Deinotherium bozasi* about 9 tonnes, *D. levius* about 10 tonnes, while *D. giganteum* and *D. proavum* greatly exceeded 10 tonnes (Larramendi 2016). All the Deinotheriidae representatives are therefore mega herbivores, i.e. mammals that feed on plants and reach a body mass of at least a tonne or more at an adult age (Owen-Smith 1988). Throughout the terrestrial mammals evolution, a maximal limit of body mass of the mega herbivores could be of approximately 17 tonnes, estimated weight for *Paraceratherium transouralicum* (Rhinocerotidae of the lower Oligocene in Eurasia) and some specimens of *Deinotherium* from the late Miocene of Eurasia and Africa (Smith et al. 2010). Nowadays, mega herbivores include elephants, most of rhinoceros, hippopotamus and giraffes, however none of these mammals reach 10 tonnes (Owen-Smith 1988).

The body size and mass of mammals is linked to a large number of phylogenetic and ecologic traits (Blueweiss et al. 1978, Brown et al. 2004). The lifestyle, the living environment and the distribution of the species are parameters particularly linked to the size (for a synthesis see McNab 1990 and Eisenberg 1990). Having a large body size and mass brings consequently negligible advantages for the survival of a population, such as a lower mortality rate, a more stable population dynamic and a better resistance to sickness and limiting environment factors (Langer 2003, Erb et al. 2001). Among large mammals, the mega herbivores are more immunised against the predation thanks to their huge size and mass, providing also a protection to the youngest because of their generally gregarious behaviour (Hummel & Clauss 2008). This advantage might have been particularly important during the Miocene that also sees a significant size augmentation of some predators (e.g., *Hyainailouros sulzeri*, *Amphicyon giganteus*, *Machairodus giganteus*; Agustí & Antón 2002). Due to the opening of environments during the Neogene (e.g. Suc et al. 1999, Favre et al. 2007, Costeur et al. 2007, Costeur & Legendre 2008), the folivore herbivores, such as the ones, also had to browse more distances from an arboreal patch to another to find food. Large mammals present a potential of geographic distribution and of displacement more important on long distances (e.g. Brown 1995, Gaston 2003), the displacements indeed less energy per distance unit for large animals (Owen-

Smith 1988). More important size and mass were therefore favourable in the environmental context of the Miocene in Europe. Lastly, the appearance of the first really large European species of *Deinotherium* (*D. levius*, *D. giganteum*) occurred in the middle Miocene, period corresponding to the global fall of temperatures (Mid-Miocene Cooling Event, ca. 14.8-14.1 Ma; Flower & Kennett 1994). According to the Bergmann law (Bergmann 1847, Blackburn & Hawkins 2004), although this rule suffers from numerous exceptions (Meiri & Dayan 2003), a large body mass also allows a limitation of the heat loss and presents a significant advantage in a colder climate. All these advantages linked to large size and mass could have supported the natural selection of larger deinotheres and in turn could explain the regular augmentation of size of this family during the Neogene.

The structure of the carnassial teeth of deinotheres, although lophodonts like extant elephants, is more specifically bilophodont and in fact closer to apes. The latter are essentially folivores and spend up to 90% of their active time to feed on fruits, leaves, barks and flowers (Huttunen 2002a, Sanders 2018, Naranjo 2009). Likewise, deinotheres seem specialised in a regime consisting of dicotyledon leaves and are generally linked to open forest environments (Konidaris et al. 2017, Čkonjević & Radović 2012, Aiglstorfer and al. 2014).

In the more derived representatives of *Deinotherium*, the occiput is slightly inclined backwards and the occipital condyles elevated, characterizing a higher head posture. The appendicular skeleton also presents a modification of the graviportal structure initially known in *Prodeinotherium* leading to a more agile anatomic type with notably a greater amplitude of movements for the anterior limbs (scapular spine without acromion and metacromion, functional tetradactyly with a reduction of the first metacarpal and first metatarsal; Huttunen 2002a). Therefore the association of the body size and mass and the anatomic evolution of Deinotheriidae suggests an ecological evolution at a family level, favouring the more mobile and larger species, adapted to more open and scattered forest landscapes. Such an evolutionary history could explain the progressive displacement of Deinotheriidae during the Miocene to Eastern Europe, where a drier climate (Eronen et al. 2010, Bruch et al. 2011) had probably favoured this type of environment.

## Conclusion

During the MN4-5 interval, only the small-sized deinotheres are present and essentially in Western Europe. Since MN6, the arrival of large sizes is recorded, up to three species when coexisted during the MN6-7/8 interval. During the late Miocene (MN9-12-early MN13) and the beginning of the Pliocene (late MN13), deinotheres were gradually restricted to Eastern Europe, sort of refuge area, where only larger species remained. Two factors seem to explain this palaeobiogeographic dynamic,



the climatic evolution during the Miocene leading to a differentiation between the environments of Western and of Eastern Europe, and the ecological evolution of the *deinotheres* here. Since the beginning of the Miocene, Europe underwent numerous climatic changes that divided the continent in two really distinct environments from the late Miocene onward. Indeed, Western Europe environments were dominated by still closed and semi-humid tropical forests whereas Eastern Europe had more open and drier forests landscapes due to a more continental climate (Vislobokova & Sotnikova 2001). *Deinotheres* being folivores were clearly linked to forest environments and needed large quantities of foliage along the year to sustain the amount of energy that their huge body mass required. The combination of their specialised diet and morphologic evolution (higher head posture, increased size and improved agility) reflects a remarkable adaptive and ecologic evolution of the family allowing their representatives to survive and flourish in Europe during the Miocene environmental transition. However, after having reached giant sizes and masses by the end of the Miocene, the extreme opening of the landscapes and the development of seasonal forests with deciduous leaves limiting the food supply (Kovar-Eder 2003, Suc et al. 1999, Jiménez-Moreno et al. 2010) could have initiated the disappearance of the family.

## Acknowledgements

The authors express their gratitude to Loïc Costeur for giving them access to the collection of deinotheres hosted at the Natural History Museum of Basel and to Renaud Roch who produced copies of some of the specimens. This research was supported by two research grants from the Swiss National Foundation for Science (SNF-200021\_162359 attributed to DB and OM, and SNF-CKSP\_190584 attributed to OM).

## References

- Agustí J. & Antón M. 2002: *Mammoths, Sabertooths, and Hominids. 65 Million Years of Mammalian Evolution in Europe*. Columbia University Press, New York.
- Aiglstorfer M., Göhlich U.B., Böhme M. & Gross M. 2014: A Partial Skeleton of *Deinotherium* (Proboscidea, Mammalia) from the Late Middle Miocene Gratkorn Locality (Austria). *Palaeobiodiversity and Palaeoenvironments* 94, 49-70. [doi.org/10.1007/s12549-013-0140-x](https://doi.org/10.1007/s12549-013-0140-x)

- Andrews C.W. 1911: On a New Species of *Dinotherium* (*Dinotherium hobleyi*) from British East Africa. *Proceedings of the Zoological Society of London* 81, 943-45. [doi.org/10.1111/j.1096-3642.1911.tb01964.x](https://doi.org/10.1111/j.1096-3642.1911.tb01964.x)
- Antoine P.O., Welcomme J.L., Marivaux L., Baloch I., Benammi M. & Tassy P. 2003. First record of Paleogene Elephantoidea (Mammalia, Proboscidea) from the Bu  Hills of Pakistan. *Journal of Vertebrate Paleontology* 23, 977-980.
- Arambourg C. 1934: Le *Dinotherium* des gisements de l'Omo (Abyssinie). *Bulletin de la Société géologique de France* 5, 305-310.
- Azanza B., Cerdeño E., Ginsburg L., van der Made J., Morales J. & Tassy P. 1993: Les grands mammifères du Miocène inférieur d'Artesilla, bassin de Calatayud-Teruel (Province de Saragosse, Espagne). *Bulletin du Muséum National d'Histoire Naturelle de Paris* 15, 105-153.
- Bachmann I. 1875: Beschreibung eines Unterkiefers v. *Dinotherium bavaricum*. *Abhandlungen der Schweizerischen paläontologischen Gesellschaft*, 2.
- Belyaeva E.I. 1948: Catalogue  tertiary Fossil Sites of the Land Mammals in the U.S.S.R. [M. Uhen/M. Uhen].
- Berger J.-P. 2011: Du bassin molassique au fossé rhénan: évolution des paléoenvironnements dans un avant-pays dynamique. *Géochronique, Magazine des Géosciences* 117, 44-49.
- Bergmann C. 1847: Über die Verhältnisse der Wärmeökonomie der Thiere zu ihrer Grösse, *Göttinger Studien*, 3, 595-708.
- Blackburn, T.M., & Hawkins, B.A. 2004: Bergmann's rule and the mammal fauna of northern North America, *Ecography*, 27, 715–724.
- Blueweiss, L., Fox, H., Kudzma, V., Nakashima, D., Peters, R. & Sams, S. 1978: Relationships between body size and some life history parameters, *Oecologia*, 37(2), 257–272.
- Böhme M. 2003: The Miocene Climatic Optimum: Evidence from Ectothermic Vertebrates of Central Europe. *Palaeogeography, Palaeoclimatology, Palaeoecology* 195, 389-401. [doi.org/10.1016/S0031-0182\(03\)00367-5](https://doi.org/10.1016/S0031-0182(03)00367-5)
- Boev Z. & Spassov N. 2009: First record of ostriches (Aves, Struthioniformes, Struthionidae) from the late Miocene of Bulgaria with taxonomic and zoogeographic discussion. *Geodiversitas* 31(3), 493-507.
- Böhme M., Aiglstorfer M., Uhl D. & Kullmer O. 2012: The Antiquity of the Rhine River: Stratigraphic Coverage of the Dinotheriensande (Eppelsheim Formation) of the Mainz Basin (Germany). *PLoS ONE* 7, e36817.
- Bonaparte C.L.J.L. 1845: *Catalogo Metodico die Mammiferi Europei*. Coi tipi di L. di Giacomo Pirola, Milan.
- Brown J.H. 1995: *Macroecology*. The University of Chicago Press, Chicago.

- Brown J.H., Gillooly J.F., Allen A.P., Savage V.M. & West, G.B. 2004: Toward a metabolic theory of ecology, *Ecology*, 85(7), 1771–1789.
- Bruch A.A., Utescher T., & Mosbrugger V. 2011: Precipitation patterns in the Miocene of Central Europe and the development of continentality, *Palaeogeography Palaeoclimatology Palaeoecology*, 304, 202–211, doi.org/10.1016/j.palaeo.2010.10.002
- Chaimanee Y., Suteethorn V., Jintasakul P., Vidthayanon C., Marandat B. & Jaeger J.-J. 2004: A New Orang-Utan Relative from the Late Miocene of Thailand. *Nature* 427, 439-41. doi.org/10.1038/nature02245
- Choffat K. & Becker D. 2017: Les grands mammifères du Miocène supérieur de Charmoille (Jura, Suisse). *Actes de la Société jurassienne d'émulation* 119, Porrentruy, 29-57.
- Čkonjević B. & Radović P. 2012: *Deinotherium giganteum* from Adrani, central Serbia. *Bulletin of the Natural History Museum* 5, 15-20.
- Codrea V., Fărcaș C., Săsăran E. & Dica P. 2002: Late Miocene mammal fauna from Derșida (Sălaj district) and its related paleoenvironment. *Studia Universitatis Babeș-Bolyai, Special issue 1*, 119-132.
- Codrea V., Barbu O. & Bedeleian H. 2007: Middle Miocene diatom-bearing formations from western Romania. *Bulletin of the Geological Society of Greece* 40, 21. doi.org/10.12681/bgsg.16329
- Codrea V. & Margin C. 2009: The environments of the uppermost Miocene vertebrates from Derșida (Northwestern Rumania, Sălaj county). *Muzeul Olteniei Craiova. Oltenia. Studii și comunicări. Științele Naturii*, Tom. XXV/2009.
- Costeur, L., & Legendre, S. 2008: Mammalian communities document a latitudinal environmental gradient during the Miocene optimum in western Europe, *Palaios*, 23, 280–288.
- Costeur, L., Legendre, S., Aguilar, J.-P., & Lécuyer, C. 2007: Marine and continental synchronous climatic records: Towards a revision of the European Mid-Miocene mammalian biochronological framework, *Geobios*, 40, 775–784.
- Duranthon F., Antoine P.O., Laffont D. & Bilotte M. 2007: Contemporanéité de *Prodeinotherium* et *Deinotherium* (Mammalia, Proboscidea) à Castelnau-Magnoac (Hautes-Pyrénées, France). *Revue de Paléobiologie* 10, 403-411.
- Éhik J. 1930: *Prodeinotherium hungaricum* n. g., n. sp. *Geologica Hungarica, Series Palaeontologica* 6, 1-24.
- Eichwald E. 1835: De pecorum et pachydermorum reliquiis fossilibus in Lithuania, Volhynia et Podolia repertis. *Nova acta Academiae Caesareae Leopoldino-Carolinae Germanicae Naturae Curiosorum* 17, 677-780.



- Eisenberg, J.F. 1990: The behavioral/ecological significance of body size in the Mammalia. In: Damuth J., MacFadden B.J. (eds) *Body size in mammalian paleobiology: estimation and biological implications*. Cambridge University Press, Cambridge, pp 25-37.
- Engesser B. & Mödden C. 1997: A new version of the biozonation of the Lower Freshwater Molasse (Oligocene and Aegian) of Switzerland and Savoy on the basis of fossil mammals. In: Aguilar J.-P., Legendre S. & Michaux J. (Eds.). *Actes du Congrès Biochrom'97*. Ecole pratique des hautes études-Sciences de la vie et de la terre, Institut de Montpellier, Montpellier, 475-499.
- Erb, J., Boyce, M.S., Stenseth, N.C. 2001: Population dynamics of large and small mammals, *Oikos*, 92, 3-12.
- Eronen J.T., Puolamäki K., Liu L.P., Lintulaakso K., Damuth J., Janis C. & Fortelius M. 2010: Precipitation and large herbivorous mammals, part II: Application to fossil data. *Evolutionary Ecology Research* 12, 235-248.
- Eronen J.T., Puolamäki K., Liu L., Lintulaakso K., Damuth J., Janis C. & Fortelius M. 2010: Precipitation and large herbivorous mammals, part II: Application to fossil data. *Evolutionary Ecology Research* 12, 235-248
- Falconer H. 1868: On the European Pliocene and Pliocene species of the genus *Rhinoceros*. In: Murchison C. (Ed.). *Palaeontological memoirs and notes of the late Hugh Falconer* vol. 2 (London), 309-403.
- Favre, E., François, L., Fluteau, F., Cheddadi, R., Thévenod, L., & Suc, J.-P. 2007: Messinian vegetation maps of the Mediterranean region using models and interpolated pollen data, *Geobios*, 40, 433-443.
- Flower P.B. & Kennett J.P. 1994: The middle Miocene climatic transition: East Antarctic ice sheet development, deep ocean circulation and global carbon cycling. *Palaeogeography, Palaeoclimatology, Palaeoecology* 108, 537-555.
- Gaston, K.J. 2003: *The structure and dynamics of geographic ranges*. Oxford University Press, Oxford.
- Gheerbrant E. 2009: Paleocene Emergence of Elephant Relatives and the Rapid Radiation of African Ungulates. *Proceedings of the National Academy of Sciences* 106, 10717-10721. [doi.org/10.1073/pnas.0900251106](https://doi.org/10.1073/pnas.0900251106)
- Ginsburg L. & Chevrier F. 2001: Les dinotheres du bassin de la Loire et l'évolution du genre *Deinotherium* en France. *Symbioses* n.s. 5, 9-24.
- Göhlich U.B. 1999: Order Proboscidea. In: Rössner G.E. & Heissig K. (Eds.). *The Miocene Land Mammals of Europe*. Verlag Dr Friedrich Pfeil, München, 157-174.
- Gräf I.E. 1957: Die Prinzipien der Artbestimmung bei *Deinotherium*. *Palaeontographica* 180 (A), 131-185.
- Greppin J.-B. 1867: *Essai géologique sur le Jura suisse*. Helg & Boéchat, Delémont.

- Greppin J.-B. 1870: Description géologique du Jura bernois. *Matériaux pour la carte géologique de la Suisse* 8, 1-357.
- Harris J.M. 1973: *Prodeinotherium* from Gebel Zelten, Libya. *Bulletin of the British Museum (Natural History), Geology*, 23, 285-350.
- Harris J.M. 1983: *The Fossil Ungulates: Proboscidea, Perissodactyla and Suidae. Koobi Fora Research Project (vol 2)*. Clarendon Press, Oxford.
- Harris J.M., Brown F.H. & Leakey M.G. 1988: Stratigraphy and paleontology of Pliocene and Pleistocene localities west of Lake Turkana, Kenya. *Natural History Museum of Los Angeles County, Contribution in Science* 399, 1-128.
- Hilgen F.J., Lourense L.J. & Van Dam J.A. 2012 : The Neogene period. In: Gradstein F.M., Ogg J.G., Schmitz M.D. & Ogg G.M. (Eds.). *The geological time scale 2012. Volume 2*. Elsevier, Oxford, 923–978.
- Hummel J. & Clauss M. 2008: Megaherbivores as pacemakers of carnivore diversity and biomass: distributing or sinking trophic energy? *Evolutionary Ecology Research* 10, 925-930.
- Hutchinson J. R., Delmer C., Miller C. E., Hildebrandt T., Pitsillides A.A. & Boyde A. 2011: From Flat Foot to Fat Foot: Structure, Ontogeny, Function, and Evolution of Elephant “Sixth Toes”. *Science* 334, 1699-1703. [doi.org/10.1126/science.1211437](https://doi.org/10.1126/science.1211437)
- Huttunen K. 2002a: Systematics and Taxonomy of the European Deinotheriidae (Proboscidea, Mammalia). *Annalen des Naturhistorischen Museums in Wien* 103 A, 237-250.
- Huttunen K. 2002b: Deinotheriidae (Proboscidea, Mammalia) dental remains from the Miocene of Lower Austria and Burgenland. *Annalen des Naturhistorischen Museums in Wien* 103 A, 251-285.
- Huttunen K. & Göhlich U.B. 2002: A partial skeleton of *Prodeinotherium bavaricum* (Proboscidea, Mammalia) from the middle Miocene of Unterzolling (Upper Freshwater Molasse, Germany). *Geobios* 35, 489-514.
- Illiger C.D. 1811 : *Prodomus systematis mammalium et avium additis terminis zoographicis classis*. Gleditsch, Berlin.
- Jiménez-Moreno, G., Fauquette, S., & Suc, J.-P. 2010: Miocene to Pliocene vegetation reconstruction and climate estimates in the Iberian Peninsula from pollen data, *Review of Palaeobotany and Palynology*, 162, 403–415. [doi.org/10.1016/j.revpalbo.2009.08.001](https://doi.org/10.1016/j.revpalbo.2009.08.001)
- Jourdan M. 1861: Restes fossiles de deux grands mammifères. *Annales des sciences naturelles* 16 (4), 369-374.
- Kälin D. 1993: *Stratigraphie und Säugetierfaunen der oberen Süßwassermolasse der Nordwestschweiz*. Thèse inédite de l’université de Zurich, 238 p.
- Kälin D. 1997: Litho- und Biostratigraphie der mittel- bis obermiozänen Bois de Raube-Formation (Nordwestschweiz). *Eclogae Geologicae Helvetiae* 90, 97-114.

- Liniger H. 1925: Geologie des Delsberger Beckens und der Umgebung von Movelier. *Beiträge zur Geologischen Karte der Schweiz* 55, 1-71.
- Linnaeus C. 1758: *Systema Naturae per regna tria naturae, secundum classes, ordines, genera, species, cum characteribus, differentiis, synonymis, locis. Vol. 1: Regnum animale*. 10th edition, Stockholm.
- Kaup J.J. 1829: Neues Säugthier, *Deinotherium: Deinotherium giganteum*. *Isis* 22 (4), 401–404.
- Kaup J.J. 1832: Description d'ossements fossiles de mammifères inconnus jusqu'à présent, qui se trouvent au Muséum grand-ducal de Darmstadt. J.G. Heyer, Darmstadt.
- Konidaris G.E., Roussiakis S.J., Athanassiou A. & Theodorou G.E. 2017: The huge-sized *Deinotherium proavum* (Proboscidea, Mammalia) from the Late Miocene Localities Pikermi and Halmyropotamos (Greece). *Quaternary International* 445, 5-21. [doi.org/10.1016/j.quaint.2017.07.038](https://doi.org/10.1016/j.quaint.2017.07.038)
- Koufos G.D., Zouros N. & Mourouzidou O. 2003: *Prodeinotherium bavaricum* (Proboscidea, Mammalia) from Lesvos Island, Greece; the Appearance of *Deinotherium* in the Eastern Mediterranean. *Geobios* 36, 305-15. [doi.org/10.1016/S0016-6995\(03\)00031-7](https://doi.org/10.1016/S0016-6995(03)00031-7)
- Kovachev D. & Nikolov I. 2006: *Deinotherium thraceiensis* sp. nov. from the Miocene near Ezerovo, Plovdiv District. *Geologica Balcanica* 35 (3–4), 5-40.
- Kovar-Eder, J. 2003: Vegetation dynamics in Europe during the Neogene, *Deinotherium*, 10, 373-392.
- Langer, P. 2003: Lactation, weaning period, food quality, and digestive tract differentiations in Eutheria, *Evolution*, 57(5), 1196-1215.
- Larramendi A. 2016: Proboscideans: Shoulder Height, Body Mass and Shape. *Acta Palaeontologica Polonica* 61, 537-574. [doi.org/10.4202/app.00136.2014](https://doi.org/10.4202/app.00136.2014)
- Maridet O. & Costeur L. 2010: Diversity Trends in Neogene European Ungulates and Rodents: Large-Scale Comparisons and Perspectives. *Naturwissenschaften* 97 (2), 161-72. [doi.org/10.1007/s00114-009-0623-9](https://doi.org/10.1007/s00114-009-0623-9)
- MacFadden B.J. 1992: *Fossil horses. Systematics, paleobiology, and evolution of the family Equidae*. Cambridge University Press, Cambridge, New York, Melbourne, Madrid.
- McNab, B. 1990: The physiological significance of body size. In: Damuth J, MacFadden BJ (eds) *Body size in mammalian paleobiology: estimation and biological implications*, Cambridge University Press, Cambridge, pp 11–24.
- Mein P. 1999: European Miocene Mammal Biochronology. In: Rössner G.E. & Heissig K. (Eds.). *The Miocene Land Mammals of Europe*. Verlag D' Friedrich Pfeil, München, 25-38.
- Meiri, S., & Dayan, T., 2003: On the validity of Bergmann's rule: *Journal of Biogeography*, v. 30, p. 331–351. [doi.org/10.1046/j.1365-2699.2003.00837.x](https://doi.org/10.1046/j.1365-2699.2003.00837.x)

- Meyer, H. von. 1831: Mittheilung an geheimen Rath von Leonhard. *Jahrbuch für Mineralogie* 1831, 296-297.
- Mirzaie Ataabadi M., Mohammadalizadeh J., Zhang Z., Watabe M., Kaakinen A. & Fortelius M. 2011: Late Miocene large mammals from Ivand (Northwestern Iran). *Geodiversitas* 33, 709-728.
- Naranjo E.J. 2009: Ecology and conservation of Baird's tapir in Mexico. *Tropical Conservation Science* 2, 140-158. [doi.org/10.1177/194008290900200203](https://doi.org/10.1177/194008290900200203)
- Owen-Smith N. 1988: *Megaherbivores: The Influence of Very Large Body Size on Ecology*. Cambridge University Press, Cambridge.
- Pickford M. 2003: New Proboscidea from the Miocene strata in the lower Orange River Valley, Namibia. *Memoir of the Geological Survey of Namibia* 19, 207-256.
- Pickford M. & Pourabrishami Z. 2013: Deciphering Dinotheriensande deinotheriid diversity. *Palaeobiodiversity and Palaeoenvironments* 93 (2): 121-150. [doi.org/10.1007/s12549-013-0115-y](https://doi.org/10.1007/s12549-013-0115-y)
- Poulakakis N., Lymberakis P. & Fassoulas C. 2005: Reviewed work(s). *Deinotherium giganteum* (Proboscidea, Deinotheriidae) from the Late Miocene of Crete. *Journal of Vertebrate Paleontology* 25, 732-36.
- Prieto J., Becker D., Rauber G. & Pirkenseer C.M. 2017: New Biostratigraphical data for the Burdigalian Montchaibeux Member at the Locality Courrendlin-Solé (Canton of Jura, Switzerland). *Swiss Journal of Geosciences* 111, 1-11. [doi.org/10.1007/s00015-017-0285-0](https://doi.org/10.1007/s00015-017-0285-0)
- Rai Y.C. 2004: Fossil elephants from the Indian sub-continent and their tusks: A review. *Journal Palaeontological Society of India* 49, 169-188.
- Rögl F. 1996: Stratigraphic correlation of the Paratethys Oligocene and Miocene. *Mitteilungen der Gesellschaft der Geologie und Bergbaustudenten Österreichs* 41, 65-73.
- Rögl F. 1999a: Mediterranean and Paratethys. Facts and hypotheses of Oligocene to Miocene palaeogeography (short overview). *Geologica Carpathica* 50, 339-349.
- Rögl F. 1999b: Circum-Mediterranean Miocene palaeogeography. In: Rössner G.E. & Heissig K. (Eds.). *The Miocene Land Mammals of Europe*. Verlag Dr. Friedrich Pfeil, München, 39-48.
- Rouchy J.M., Suc J.P., Ferrandini J. & Ferrandini M. 2006: The Messinian Salinity Crisis revisited. *Sedimentary Geology*, 188-189, 1-8.
- Sanders W.J. 2018: Proboscidea from Kanapoi, Kenya». *Journal of Human Evolution*, S0047248418303919. [doi.org/10.1016/j.jhevol.2018.10.013](https://doi.org/10.1016/j.jhevol.2018.10.013)
- Sanders W.J., Kappelman J. & Rasmussen D.T. 2004: New large-bodied mammals from the late Oligocene site of Chilga, Ethiopia. *Acta Paleontol. Polonica* 49 (3), 365-392. <http://www.app.pan.pl/archive/published/app49/app49-365.pdf>

- Sankhyan A.R. & Sharma S.L. 2014: *In situ* dental remains of *Deinotherium* from northwest Indian Siwalik. *Himalayan Geology* 35 (1), 75-81.
- Schäfer H. 1961: Die pontische Säugetierfauna von Charmoille (Jura bernois). *Eclogae Geologicae Helvetiae* 54, 559-566.
- Sen S. 2013: Dispersal of African Mammals in Eurasia during the Cenozoic: Ways and Whys. *Geobios* 46, 159-72. [doi.org/10.1016/j.geobios.2012.10.012](https://doi.org/10.1016/j.geobios.2012.10.012)
- Sissingh W. 2006: Syn-kinematic palaeogeographic evolution of the West European Platform: correlation with Alpine plate collision and foreland deformation. *Netherlands Journal of Geosciences* 85, 131–180.
- Smith F.A., Boyer A.G., Brown J.H., Costa D.P., Dayan T., Ernest S.K.M. & Evans A.R. 2010: The Evolution of Maximum Body Size of Terrestrial Mammals. *Science* 330, 1216-1219. [doi.org/10.1126/science.1194830](https://doi.org/10.1126/science.1194830)
- Stehlin H.G. 1914: Übersicht über die Säugetiere der schweizerischen Molasseformation, ihre Fundorte und ihre stratigraphische Verbreitung. *Verhandlungen der Naturforschenden Gesellschaft in Basel* 25, 170-193.
- Steininger F.F. 1999: Chronostratigraphy, Geochronology and Biochronology of the Miocene “European Land Mammal Mega-Zones (ELMMZ)” and the Miocene “Mammal-Zones (MN-Zones)”. In: Rössner G.E. & Heissig K. (Eds.). *The Miocene Land Mammals of Europe*. Verlag Dr Friedrich Pfeil, München, 9-24.
- Suc, J.-P., Fauquette, S., Bessedik, M., Bertini, A., Zheng, Z., Clauzon, G., Suballyova, D., Diniz, F., Quézel, P., Feddi, N., Clet, M., Bessais, E., Taoufiq, N.B., Méon, H., & Combourieu-Nebout, N. 1999: Neogene vegetation changes in West European and West circum-Mediterranean areas, in: Agusti, J., Rook, L., Andrews, P. (Eds.), *Hominoid Evolution and Climatic Change in Europe, Volume 1. The Evolution of Neogene Terrestrial Ecosystem in Europe, Hominid Evolution and Climate in Europe*. Cambridge, pp. 378-388.
- Tassy P. 1990: The “Proboscidean Datum Event:” How Many Proboscideans and How Many Events? In: Lindsay E.H., Fahlbusch V. & Mein P. (Eds.). *European Neogene Mammal Chronology*. Springer US, Boston, MA, 237-252.
- The Paleobiology Data base. [data extracted on the 09.08.2019]. URL: <https://paleobiodb.org/navigator/>
- Țibuleac P. 2018: Two Medium-Sized Dinotheres (Proboscidea: Mammalia) from the Miocene Rocks of the Eastern Carpathians Foreland (Romania). *Geological Quarterly* 62 (3), 669-684. <https://doi.org/10.7306/gq.1430>

Vergiev S. & Markov G.N. 2010: A mandible of *Deinotherium* (Mammalia: Proboscidea) from Aksakovo near Varna, Northeast Bulgaria. *Palaeodiversity* 3, 241-247.

Vislobokova I.A. & Sotnikova M.V. 2001: Pliocene faunas with Proboscideans of the Former Soviet Union. In: Cavaretta G., Gioia P., Mussi M. & Palombo M.R. (Eds.). *The World of Elephants. Proceedings of the 1st International Congress, Consiglio Nazionale delle Ricerche - Roma*, 157-160.

Welcomme J.L., Antoine P.-O., Duranthon F., Mein P. & Ginsburg L. 1997: Nouvelles découvertes de vertébrés miocènes dans le synclinal de Dera Bugti (Balouchistan, Pakistan). *Comptes Rendus de l'Académie des Sciences. Sciences de la Terre et des Planètes* 325, 531-536.

**Appendix 1.**  of the European localities where are registered the Deinotheriidae species.